



COSTRUZIONE APPARECCHIATURE ELETTRONICHE - OLEODINAMICHE - INDUSTRIALI
42028 - POVIGLIO - (R.E.) - Via Parma, 59 - ITALIA
Tel. +39 0522 960050 (r.a.) - Fax +39 0522 960259 - e-mail: infozapi@tin.it

INSTALLATION AND USER MANUAL CHOPPER SEM-1C



INDEX

	Page
LEGEND	3
COLOUR CODES (Single Colours)	3
1 Introduction to the ZAPI-MOS family	4
2 General characteristics	5
2.1 Technical Specification	5
2.2 Control Units	5
2.2.a Microswitches	5
2.2.b Potentiometer	6
2.3 Safety & Protection Features	7
2.4 Direction Orientation	7
2.5 Operational Features	8
2.6 SEM-1C chopper diagnosis	9
2.7 Thermal Considerations	9
2.8 General Instructions and Precautions	10
3 Installation	11
3.1 Connection Cables	11
3.2 Contactors	11
3.3 Fuses	11
3.4 Description of SEM-1C Connectors.	12
3.5 Description of Power Connections	13
3.6 Mechanical Drawing & Dimensions	14
4 Programming & Adjustments using Digital Console	15
4.1 Adjustments via Console	15
4.2 Description of Console & Connection	15
4.3 Description of Standard Console Menu	16
5 SEM-1C: cabling and configuration	17
5.1 Power diagram	17
5.2 Connections	18
5.3 Description of Programmable Functions (Options).....	19
5.4 Description of Parameters that may be Programmed	21
5.5 Table of Adjustments	23
5.6 SEM-1C Traction Standard Wiring Diagrams	25
5.7 Sequence for SEM-1C Traction Settings.	26
6 SEM-1C Diagnostics	27
6.1 Analysis of Alarms displayed on the Console	28
6.2 Tester Description of the Functions	31
6.3 Description of the Console SAVE Function	33
6.4 Description of Console RESTORE Function.	34
6.5 Description of Alarms Menu.	35
6.6 Description of Console PROGRAM VACC function.	36
7 Recommended Spare parts for SEM-1C	37
8 Periodic Maintenance to be repeated at times indicated	38

SIGNED IN APPROVAL

COMPANY DEPT. SERVICES	MANAGEMENT EXECUTIVE	
ENGINEERING SECTION EXECUTIVE		
EXPORT MANAGER		

Publication n°: **AD0ZP0CA**
Edition: **February 2000**

LEGEND

B SW	=	Belly Switch
CM	=	Common Microswitches
CPOT	=	Wiper Potentiometer
EMB	=	Electromechanical Brake
EV	=	Lowering Valve
FORW SW	=	Forward Switch
H&S	=	Hard & Soft
HORN	=	Horn
HORN SW	=	Horn Switch
LIFT SW	=	Lifting Switch
LOW SW	=	Lowering Switch
MC	=	Main Contactor
NEMB	=	Negative Electromechanical Brake
NEV	=	Negative Lowering Valve
NHORN	=	Negative Horn
NMC	=	Negative Main Contactor
NPC	=	Negative Pump Contactor
NPOT	=	Negative Potentiometer
PC	=	Pump Contactor
PEMB	=	Positive Electromechanical Brake
PEV	=	Positive Lowering Valve
PHORN	=	Positive Horn
PMC	=	Positive Main Contactor
PPC	=	Positive Pump Contactor
PPOT	=	Positive Potentiometer
REV SW	=	Reverse Switch
SR1	=	Speed Reduction 1
SR2	=	Speed Reduction 2
T SW	=	Tiller Switch

COLOUR CODES (SINGLE COLOURS)

The following Codes represent the colours of individual wires used by Zapi (unless specified otherwise).

A - Orange	M - Brown
B - White	N - Black
BB - Blue	R - Pink
C - Sky Blue	RR - Red
G - Yellow	V - Green
GG - Grey	VV - Purple

1 INTRODUCTION TO THE ZAPI-MOS FAMILY

The ZAPIMOS chopper family represents ZAPI's answer to the needs of the 90's. To ensure that products remain on the market, without running the risk of becoming technically obsolescent, the ZAPIMOS family offers the following features:

- Advanced technology.
- Economical costs.
- Maximum safety.
- Maximum flexibility.
- Open to future technical innovations.
- **Optimum level of protection.**

The design has been derived from:

- High Frequency Mos Technology .
- Real time control over the internal and external components that influence the behaviour of the machine, with self diagnosis of the checking circuits themselves.
- Stored Program Machine (SPC), where the hardware is completely separate from the functions to be configured. The programme is parametric and can easily be modified by the end user.
- Various chopper configurations can be selected by the user, without the need for hardware modifications.
- Future technological updates are made easy for the user.

The communication protocol will continue to evolve, thereby offering increasing possibilities of interaction and expansion. For this reason, the Zapimos family offers a standard dialogue mode with external systems. This allows interfacing with

commercially available machines. Zapi can offer a range of individually designed Console Software with various features and prices.

- SEM-1C meets the requirements of (IP54). This provides excellent protection against spray (water, acid.), and against the ingress of dust or small foreign particles. Access to the control logic is very simple, and allows simple substitution or replacement.
- The SEM-1C family of Choppers are suitable for operating on DC voltages from 24 to 48V inclusive, with maximum armature current up to 300A. The choppers may be used to control DC Separately Excited Motors with power ratings from 1.0KW to 3.5 KW.

2 GENERAL CHARACTERISTICS

2.1 TECHNICAL SPECIFICATION

Chopper for Separately Excited DC motors	1.0÷ 3.5kW
Regenerative Braking.	
Voltage Range	24-36-48VDC
Maximum Field Current (all the versions)	35 A
Armature Switching Frequency	16kHz
Field Switching Frequency	1kHz
Maximum Ambient temperature	+ 40°C
Minimum Ambient temperature	-30°C
Maximum temperature of Chopper	+ 80°C
Field resistance	0.3 ÷ 0.6 Ohm

VERSIONS	MAXIMUM CURRENT	BOOSTER CURRENT	VOLTAGE DROP IN FULL CONDUCTION
24V-36V	200A (3')	220A (10")	0.23V a 100A, 25°C
24V-36V	300A (2')	330A (10")	0.23V a 100A, 25°C
48V	180A (3')	200A (10")	0.18V a 50A, 25°C

2.2 CONTROL UNITS

2.2.a Microswitches

- Microswitches should have a contact resistance lower than 0.1Ω , and a leakage current lower than $100\ \mu\text{A}$.
- When full load current is being drawn, the voltage drop across the Key Switch contact must be lower than 0.1V.
- If an Electromagnetic Brake is used, the Handle Microswitch must be able to operate the Brake Coil.
- The Microswitches send a voltage signal to the microprocessor when an operating request (running) is made.

2.2.b Potentiometer

The Potentiometer should be wired in the 3 - Wire Configuration.

CPOT (B1) signal ranges from 0 to 10V.

Minimum Potentiometer Resistance : 500Ω

Maximum Potentiometer Resistance : 10kΩ

Faults can occur if the potentiometer is out of this range.

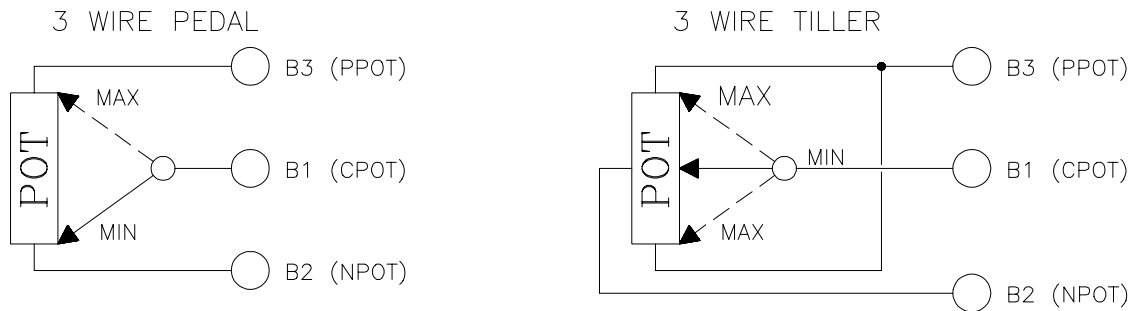

The Procedure for automatic potentiometer signal acquisition is carried out using the Console. This enables adjustment of the minimum and maximum useful signal level (PROGRAM VACC function), in either direction. This function is unique when it is necessary to compensate for asymmetry with the mechanical elements associated with the potentiometer, especially relating to the minimum level.

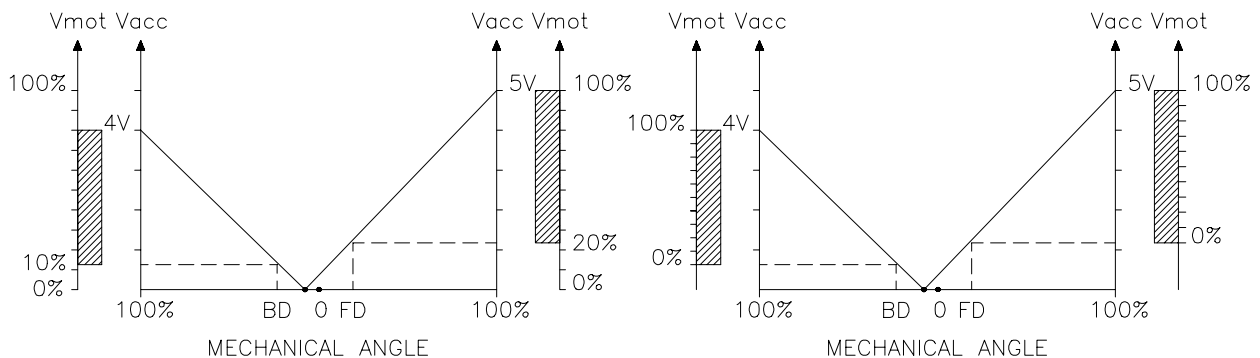

The two graphs show the output voltage from a non-calibrated potentiometer with respect to the mechanical “zero” of the control lever. MI and MA indicate the point where the direction switches close. 0 represents the mechanical zero of the rotation. The Left Hand graph shows the relationship of the motor voltage without signal acquisition being made. The Right Hand Graph shows the same relationship after signal acquisition of the potentiometer.

2.3 SAFETY & PROTECTION FEATURES

- Connection Errors :

All Inputs are protected against connection errors.

- Thermal Protection :

If the chopper temperature exceeds 70°C, the maximum current reduces in proportion to the thermal increase. The temperature can never exceed 80°C (below - 10°C, the current is reduced to 80%).

- Low Battery Charge :

When the battery charge is low, the maximum current is reduced proportionally to the battery discharge.

- Protection against accidental Start up :

A precise sequence of operations are necessary before the machine will start. Operation cannot commence if these operations are not carried out correctly. Requests for drive, must be made after closing the key Switch.

- Protection against uncontrolled movements :

The Line Contactor will not close if :

- The Power Unit is not functioning
- The Logic is not functioning perfectly.

- Main / Line Contactor :

Should be fitted to give protection to the chopper against reverse battery polarity, and safety.

- External Agents :

The chopper is protected against dust and the spray of liquid to a degree of protection meeting IP54.

2.4 DIRECTION ORIENTATION

Machines fitted with Tillers, Belly Switches, and Pulse Control Systems providing rapid reversal should conform to the requirements of Directive prEN 1175. This Directive requires that Direction Orientation should match the following drawing:

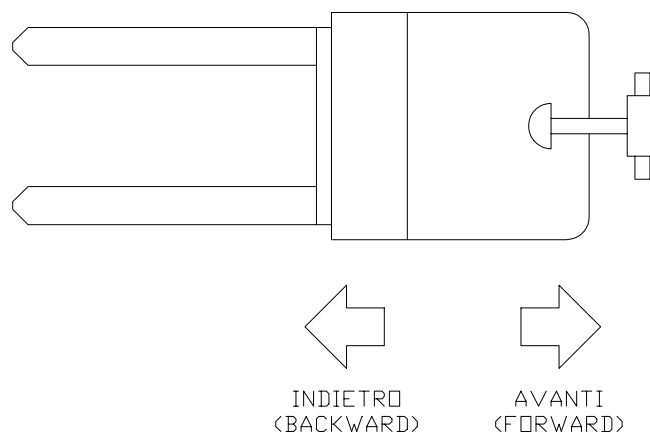

2.5 OPERATIONAL FEATURES

- Speed Control .
- Optimum sensitivity at low speeds.
- Speed Reductions in both the directions. Levels can be set using Console.
- Regenerative Braking based on deceleration ramps, in every condition.
- Three different modes of Braking : Release Braking, Inversion Braking, Speed Limit Braking.
- Speed Control during descent : the motor speed follows the accelerator. The chopper automatically brakes if the motor speed overcomes the accelerator set point. This provides optimum performance on a gradient.
- Starts on a Ramp without roll back, even without an electric brake.
- Programmable Anti Roll Back : When the Key Switch is closed, if the motor is rotating, the chopper controls the speed and automatically brakes and keeps the motor at a very low speed during descent on a gradient. This is a very useful safety feature and is not driver dependent.
- Output for Hourmeter
- The main contactor is open after 45 seconds of stand-by condition.
- Self Diagnosis with indication of fault shown via flashing Red Led. (In addition to Console Display).
- Modification of the parameters via Digital Console. See the specific description.
- Internal Hour Meter that is displayed on the Console.
- Memory of the last 5 Alarms, with relative Hour meter count and chopper temperature all displayed on the Console.
- Test Function within Console for checking main parameters. See the specific Description.
- High motor and battery efficiency due to High Frequency Switching.

2.6 SEM-1C CHOPPER DIAGNOSIS

The microprocessor continually monitors the chopper and carries out diagnostic procedures on the main functions.

The diagnosis is made in 4 points:

- 1) Diagnosis on Key Switch closing that checks: the Watch Dog Circuits, the current sensor, VMN point, Contactor Drivers, the switch sequence for operation is correct, and the output of the accelerator or tiller is correct.
- 2) Standby Diagnosis at rest that checks: VMN Point, Contactor Drivers, and Current Sensor.
- 3) Diagnosis during operation that checks: Watchdog, VMN Point, Current, Contactor(s), and VMN when in full conduction.
- 4) Continuous Diagnosis that checks: Chopper temperature, Battery Voltage.

Diagnosis is provided in 2 ways. The Red Led connected to Connector A will flash a certain number of times for a given Alarm (See Listings), or the Digital Console may be used. A permanent Alarm will be displayed on the Console immediately and the RED LED will flash. An intermittent Alarm will be recorded in the Alarm library, but the RED LED will only flash at the time of the Alarm.

2.7 THERMAL CONSIDERATIONS

- The heat generated by the power block must be dissipated. For this to be possible, the compartment must be ventilated and the heat sink materials ample.
- The heat sink material and system should be sized on the performance requirement of the machine. Abnormal ambient air temperatures should be considered. In situations where either ventilation is poor, or heat exchange is difficult, forced air ventilation should be used.
- The thermal energy dissipated by the power block module varies and is dependent on the current drawn and the duty cycle.

2.8 GENERAL INSTRUCTIONS AND PRECAUTIONS

- Never combine SCR low frequency choppers with SEM-1C modules. The filter capacitors contained in the SEM-1C module will change the SCR chopper operation and subject it to excessive workload. If it is necessary to use two or more control units (eg. Lift + traction), the choppers must be of the High Frequency Zapi family.
- Do not connect the chopper to a battery with a different nominal voltage to the value indicated on the chopper. A higher battery voltage may cause MOS failure, and a lower voltage may prevent the logic operating.
- During battery recharge, the SEM-1C must be completely disconnected from the battery. As well as altering the charge current read by the battery charger, the module can be damaged by higher than normal voltages supplied via the charger.
- The SEM-1C module should only be supplied by a traction battery. Do not use the outputs of converters or power supplies. For special applications please contact the nearest Zapi service centre.
- Start the machine the first time with the drive wheel(s) raised from the floor to ensure that any installation errors do not compromise safety.
- After operation, even with the Key Switch open, the internal capacitors may remain charged for some time. For safe operation, we recommend that the battery is disconnected, and a short circuit is made between Battery Positive and Battery negative power terminals of the chopper using a Resistor between 10Ω and 100Ω . Minimum 5 W.
- The susceptibility and electromagnetic emission levels are seriously influenced by installation conditions. Take particular care with the length of cables and wires, types of electrical connections, and braided/screened wires.
Zapi declines any responsibility for incorrect or bad operation that can be attributed to the above circumstances. Above all, the manufacturer of the machine must ensure that the requirements of EN 50081-2 are met.

3 INSTALLATION

Install the chopper baseplate onto a flat metallic surface that is clean and unpainted. Apply a thin layer of thermo-conductive grease between the two surfaces to permit better heat dissipation.

Despite the protection provided against external agents, the continuous attack of corrosive elements and substances may cause oxidization of connector contacts, resulting in bad operation. Remember this point when deciding the installation position on the vehicle.

Fix the chopper using the special holes located on the baseplate.

Verify that the wiring of the cable terminals and connectors has been carried out correctly. Ensure that suppression devices are fitted to the coils not protected by the SEM-1C itself.

3.1 CONNECTION CABLES

For the auxiliary circuits use cables better or equal to 0.5mm² section.

For power connections to the motor armature and battery use cable of 16mm² section.

For the Field connections use cable of 4mm² section.

For the optimum chopper performance, the cables to the battery should be run side by side and be as short as possible.

3.2 CONTACTORS

A Line Contactor, designed for Continuous Operation should be installed. This contactor should be fitted with a coil corresponding to the battery voltage. The current absorbed by the coil must not be greater than 3A.

Suppression for this contactor coil is within the chopper. Do not use external suppression. For any Contactor using external suppression, ensure that connections are made respecting correct polarity.

3.3 FUSES

- Use a 6.3A Fuse for protection of the auxiliary circuits.
- For protection of the power unit, refer to diagrams.. The Fuse value shown is the maximum allowable. For special applications or requirements these values can be reduced.
- For Safety reasons, we recommend the use of protected fuses in order to prevent the spread of fused particles should the fuse blow.

3.4 DESCRIPTION OF SEM-1C CONNECTORS.

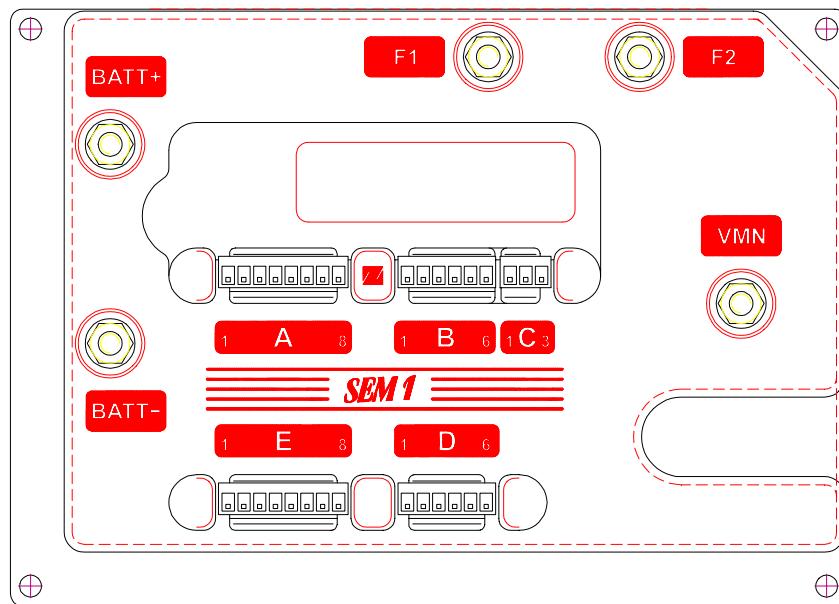

PIN REFERENCE DESCRIPTION

A1	HOURMETER	Output hourmeter; it controls a load to -BATT. Maximum output current 200mA.
A2	KEY	B+ Supply into logic downstream of 10A fuse & key switch.
A3	NMC	Negative main contactor coil.
A4	NEMB	Negative electro-brake.
A5	TILLER	Tiller micro-switch.
A6	-BATT	-BATT.
A7	PMC	Positive main contactor coil and common positive supply for REV, FORW, B SW, HORN, LIFT, LOW microswitches.
A8	H&S	Hard & Soft function input. It should be connected to A7 through the H&S switch. Active high (+VB).
B1	CPOT	Accelerator's potentiometer wiper, or output of inductive device.
B2	NPOT	Provides a negative supply to accelerator's potentiometer.
B3	PPOT	Provides a positive supply to accelerator's potentiometer.
B4	REV	Reverse direction input, it should be connected to A7 by a micro-switch. Active HIGH (+VB).
B5	B SW	Quick inversion input, it should be connected to belly button. Active HIGH (+VB).
B6	FORW	Forward direction input. It should be connected to A7 by a micro-switch, active HIGH (+VB).

<i>PIN</i>	<i>REFERENCE</i>	<i>DESCRIPTION</i>
C1	CM	Common positive supply for micro-switch SR1, SR2, (+BATT).
C2	SR1	Input for 1 st speed reduction. It should be connected to C1 by micro-switch, active LOW.
C3	SR2	Input for 2 nd speed reduction. . It should be connected to C1 by micro-switch, active LOW.
D1	REG SIGNAL	Regenerative braking status. Normally high, low while regenerating.
D2	PHORN	Positive horn, it should be connected to A7 by the horn micro-switch.
D3	NHORN	Negative horn, it is -BATT.
D4	PPC	Positive pump contactor; it should be connected to A7 by lifting micro-switch LIFT which provides the positive supply to the pump contactor's coil.
D5	NPC-NEV	Negative supply for pump contactor.
D6	PEV	Positive electro-valve for lowering.
E1	PCLRXD	Positive serial reception.
E2	NCLRXD	Negative serial reception.
E3	PCLTXD	Positive serial transmission.
E4	NCLTXD	Negative serial transmission.
E5	GND	Negative console power supply.
E6	+VL	Positive console power supply.
E7	---	Free.
E8	---	Free.

3.5 DESCRIPTION OF POWER CONNECTIONS

+BATT	=	Positive Supply from Battery.
-BATT	=	Negative Supply from Battery.
VMN	=	Negative Supply (via chopper) to Motor.
F1, F2	=	Connections to Drive Motor Field Winding.

3.6 MECHANICAL DRAWING & DIMENSIONS

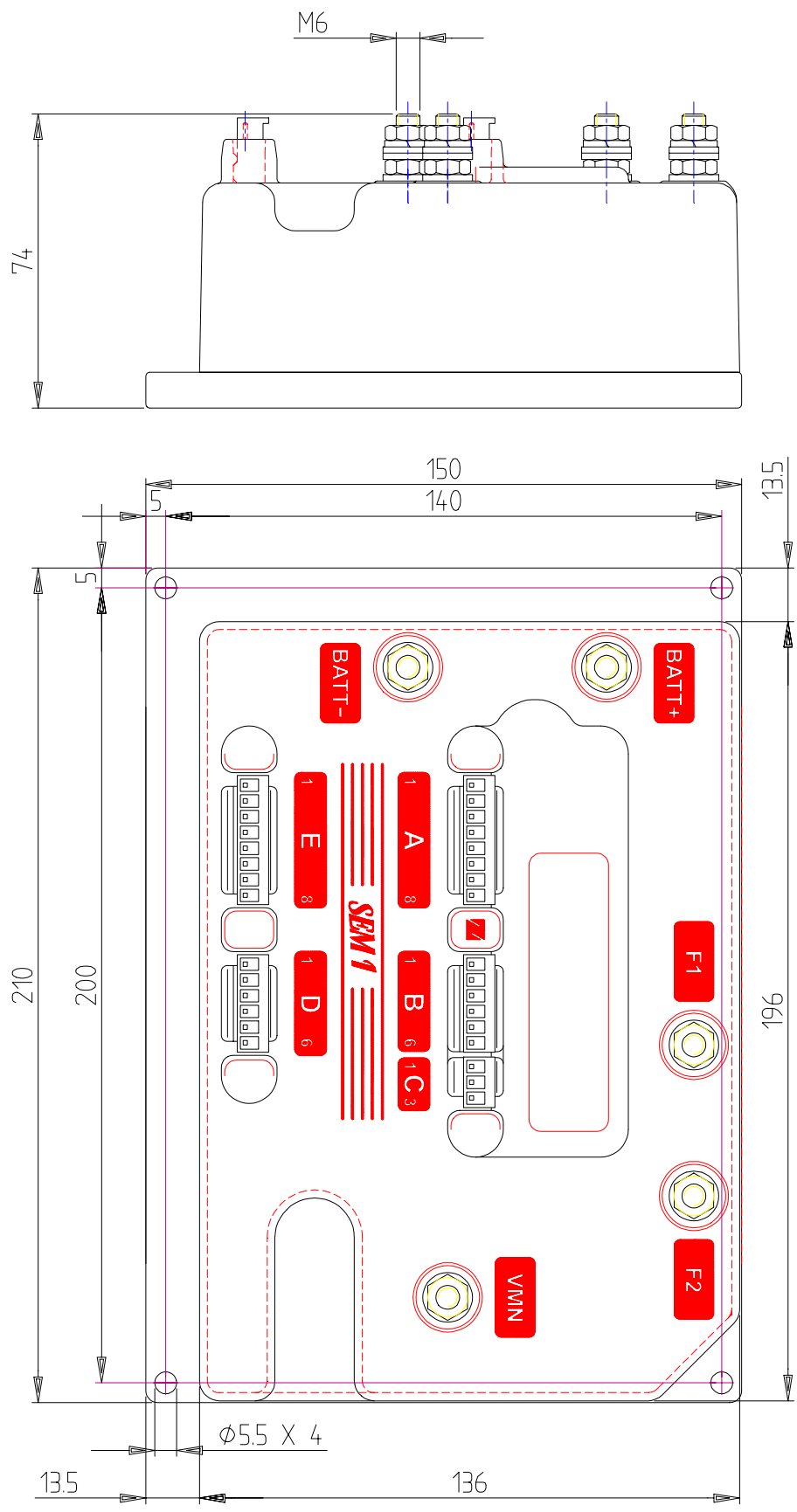

4 PROGRAMMING & ADJUSTMENTS USING DIGITAL CONSOLE

4.1 ADJUSTMENTS VIA CONSOLE

Adjustment of Parameters and changes to the chopper's configuration are made using the Digital Console. The Console is connected to the "E" connector of the SEM-1C Chopper.



Pay attention to the polarity of the Console Connector when connecting to the chopper. The bevel on the connector should be uppermost.

4.2 DESCRIPTION OF CONSOLE & CONNECTION

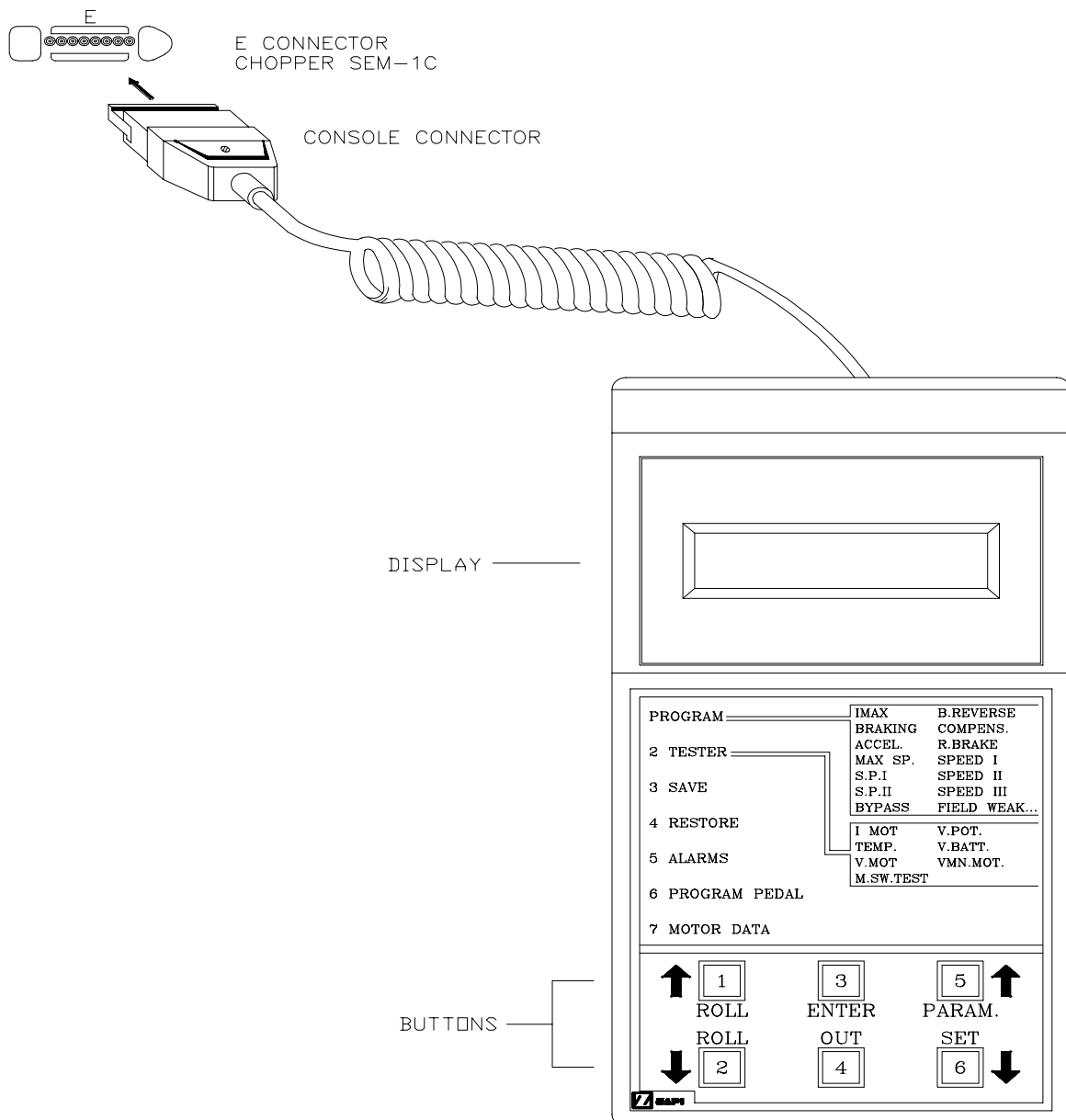

Digital Consoles used to communicate with SEM-1C choppers must be fitted with Eprom CK ULTRA.

4.3 DESCRIPTION OF STANDARD CONSOLE MENU

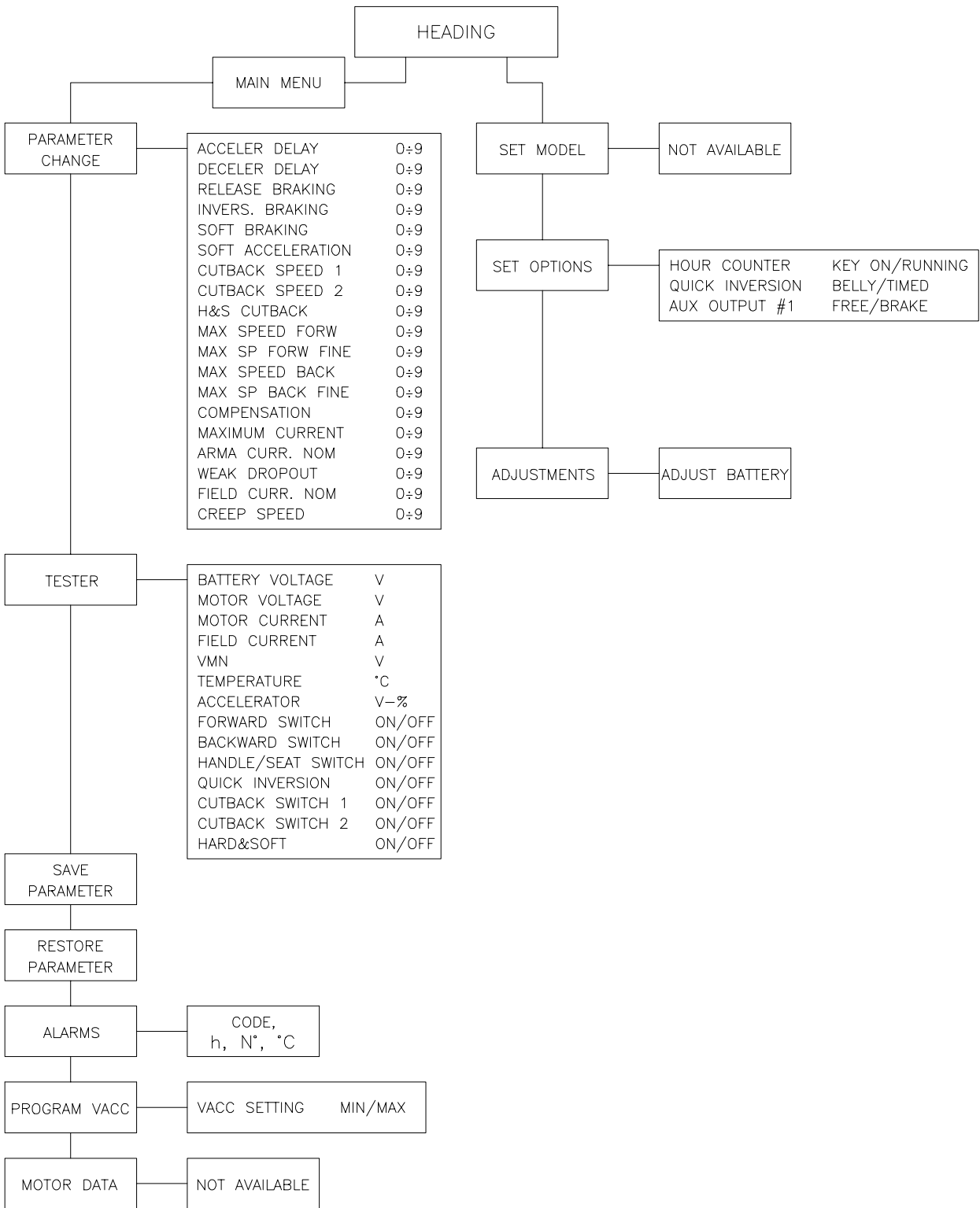

5 SEM-1C: CABLING AND CONFIGURATION

5.1 POWER DIAGRAM

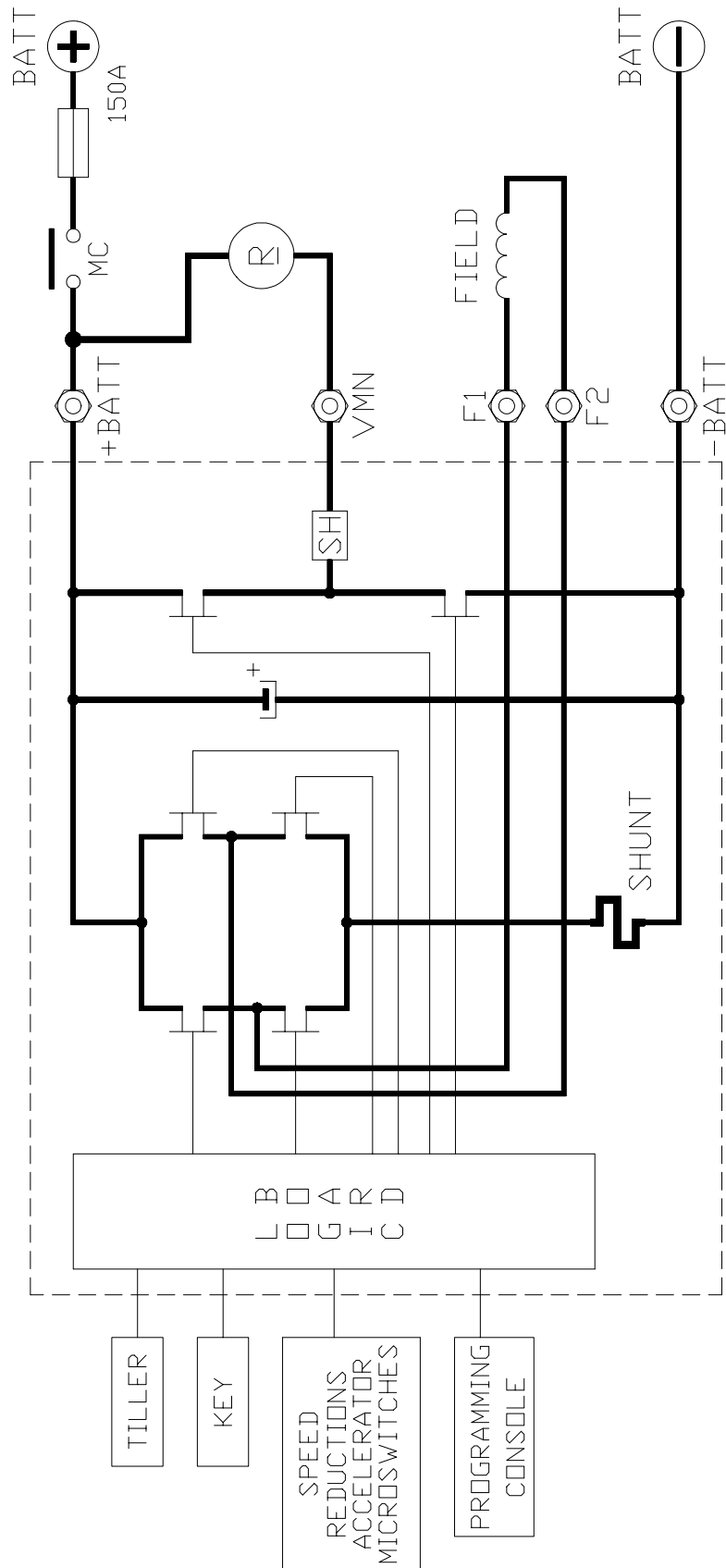

5.2 CONNECTIONS

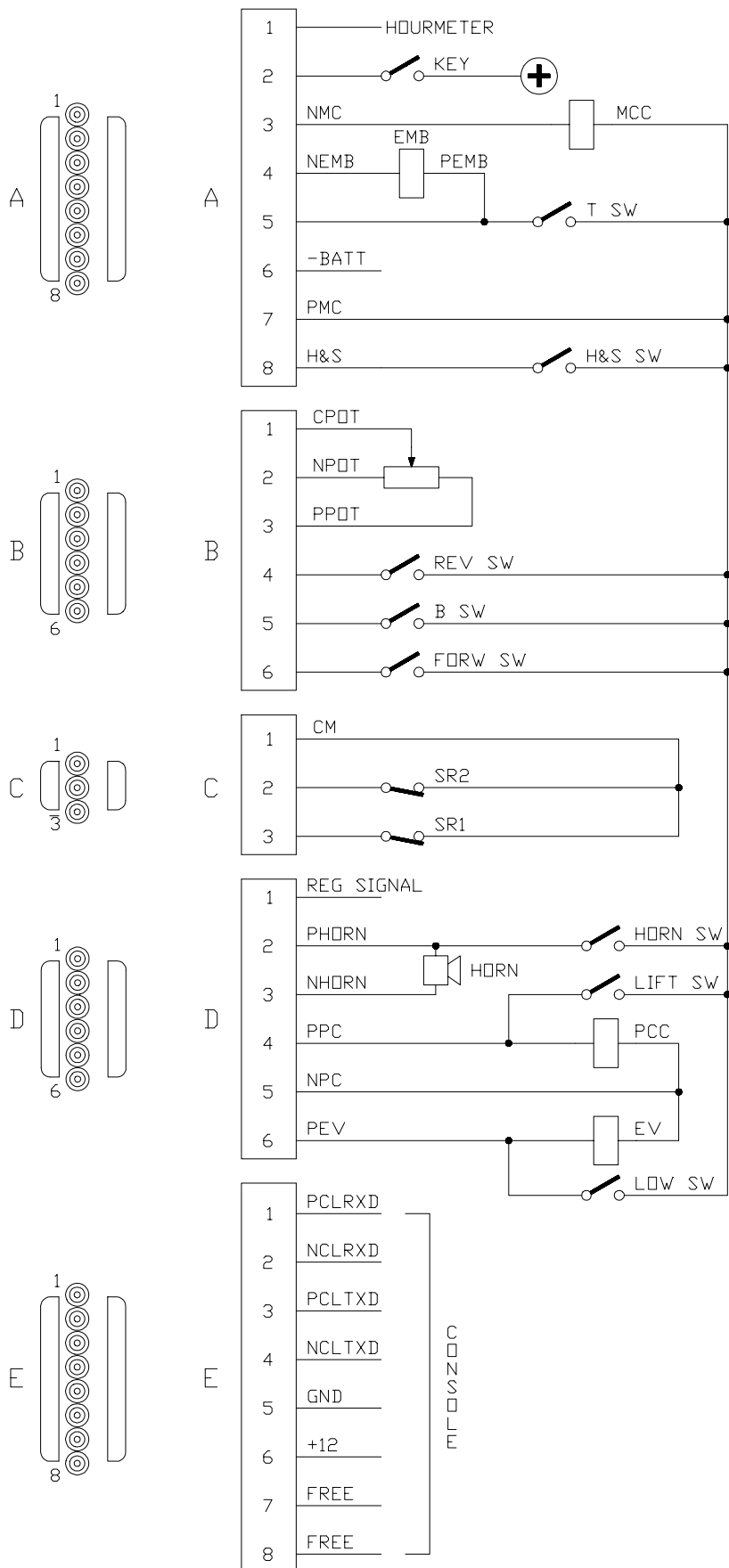

5.3 DESCRIPTION OF PROGRAMMABLE FUNCTIONS (OPTIONS).

Using the CONFIG MENU of the console, it is possible to select from the following options:

SUBMENU "SET OPTIONS":

1 HOUR COUNTER:

- RUNNING: The counter registers travel time only.
- KEY ON: The counter registers when the key switch is Closed.

The A1 output for external hourmeter operates according to internal hourmeter. If the pump contactor is connected (D4), hourmeter output (A1) is activated during lifting as well.

2 QUICK INVERSION

- BELLY: Quick inversion is activated while the Belly Button is pressed.
- TIMED: Quick inversion is activated, while the Belly Button is pressed, maximum for 2 second.

3 AUX OUTPUT #1:

- FREE: A4 output is not used: the controller carry out monitor function as described at the paragraph 2.5.
- BRAKE: A4 output drives an electromechanical brake. The controller does not carry out monitor function, but locks the brake while in rest or alarm status.

4 BATTERY CHECK

- ON Is controlled the battery charge. Whe the battery is discharged is displayed "BATTERY LOW"
- OFF Is controlled the battery charge, but not displayed the alarms.

5 SEAT SWITCH

- HANDLE a tiller switch is present
- SEAT a seat switch is present

6 BACKING INPUT

- ON The backing function is activated
- OFF The backing function is deactivated

Flow Chart showing how to make changes to Configuration Menu using Digital Console.
(Standard Eprom CK ULTRA fitted).

- 1) Opening Zapi Menu.
- 2) Press Top Left & Top Right Buttons simultaneously to enter the Config.Menu.
- 3) The Display will show :
- 4) Press ROLL UP (Top Left Button) until SET OPTIONS appears.
- 5) The Display will show :
- 6) Press ENTER to go into this part of the menu.
- 7) The first "Option" of the menu appears on the Display.
- 8) Press either ROLL UP or ROLL DOWN to bring up the next the Option.
- 9) A new Option appears on the Display.
- 10) When the desired Option is displayed, press PARAM (Top Right) or SET (Bottom Right) button to change the configuration
- 11) The new Configuration for the selected Option appears on the Display.
- 12) Press OUT to exit the Menu.
- 13) Press ENTER to accept the changes, or Press OUT if you do not accept the changes and wish to make further modifications to the particular Option.
- 14) The Display now shows:
- 15) Press OUT again. Display now shows the Opening Zapi Menu.

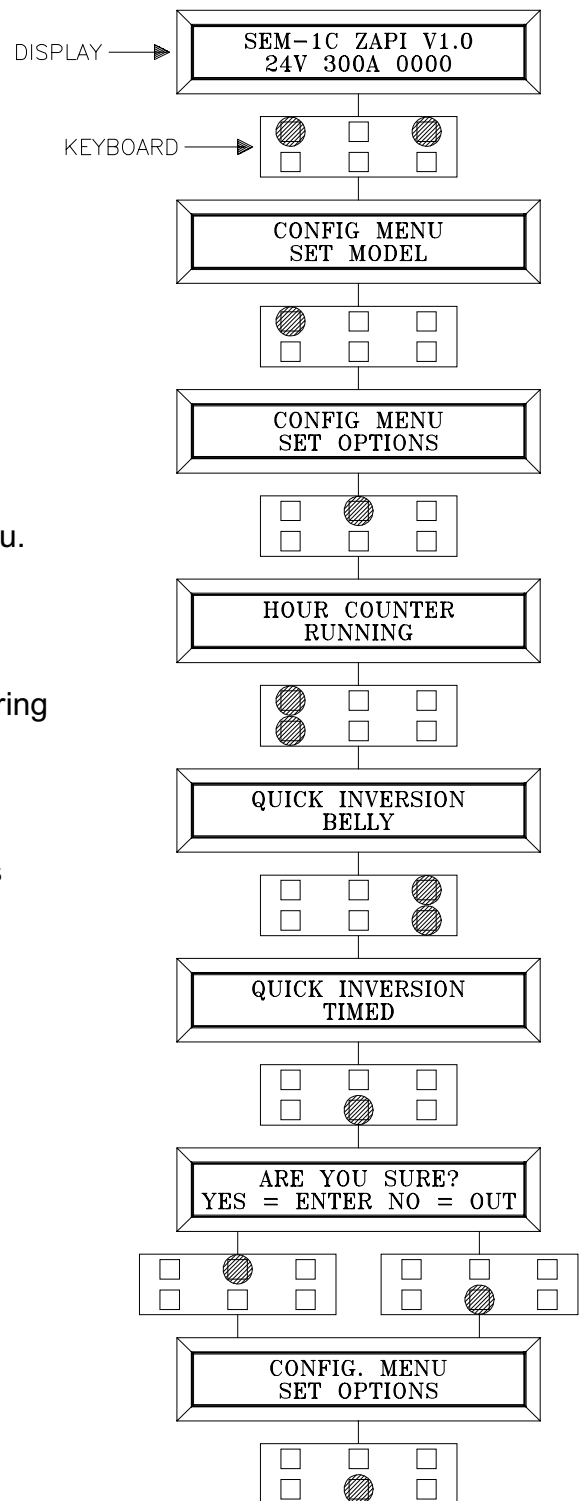

5.4 DESCRIPTION OF PARAMETERS THAT MAY BE PROGRAMMED

In addition to the Configuration, Parameter settings may be made by Zapi using standard default settings, settings to Customer Specifications, or the customer may make changes according to the application, using a Digital Console.

During the setting up procedure on the machine, the Console can remain connected to the chopper during travel. The Parameters can be modified in real time, during operation.

Pay attention to the polarity of the Console Connector. Refer to Page 15 of this Manual for connection details.

THE PROGRAMMING CONSOLE MUST BE PLUGGED ONLY WHEN THE KEY-SWITCH IS OFF.

The following Parameters can be modified :

- 1 **ACC. DELAY** = Determines the acceleration ramp.
- 2 **DECELER DELAY** = Determines the deceleration ramp according to the accelerator pedal position.
- 3 **RELEASE BRAKING** = Determines the deceleration ramp when the travel request is released.
- 4 **INVERSION BRAKING** = Determines the deceleration ramp the the Direction Switch is inverted during travel.
- 5 **SOFT BRAKING** = Determines how much the brakings are reduced when the H&S function is active.
- 6 **SOFT ACCEL.** = Determines how much the acceleration ramps are reduced when the H&S function is active.
- 7 **CUTBACK SPEED 1** = First speed reduction.
- 8 **CUTBACK SPEED 2** = Second speed reduction.
- 9 **H&S CUTBACK** = Speed reduction active when the H&S function is active.
- 10 **MAX SPEED FORW** = Maximum Forward Speed, obtained by weakening the Field Current after it has reached 100% conduction of the Armature. With the Parameter set at level 0, the armature is in total conduction but the field current does not decrease below the Nominal value (low speed).
- 11 **MAX SP FORW FINE** = Maximum forward speed.Fine adjustment.
- 12 **MAX SPEED BACK** = Maximum Reverse Speed, obtained by weakening the Field Current after it has reached 100% conduction of the Armature. With the Parameter set at level 0, the armature is in total conduction but the field current does not decrease below the Nominal value (low speed)
- 13 **MAX SP BACK FINE** = Maximum reverse speed. Fine adjustment.
- 14 **COMPENSATION** = Speed compensation when load is present. It reduces the difference between maximum speed laden and unladen.
- 15 **MAXIMUM CURRENT** = Maximum controller current.
- 16 **ARMA NOM.CURR.** = Nominal Armature Current. This parameter fixes a limit for the armature current above which the Field Current is at least the Nominal Value (FIELD NOM.CURR.), regardless of accelerator position.

- 17 WEAK DROPOUT** = This Parameter fixes a limit on the Armature Current above which the Field Current is increased linearly up to the Nominal Field Current (in proportion to the armature current).
- 18 FIELD NOM. CURR.** = Nominal Field Current. This parameter fixes the minimum Field Current when the potentiometer is between 0% and 60% without total conduction of the Armature. Adjustment should be made with reference to the Data on the Motor Label. (The indication of Nominal Field Current).
- 19 CREEP SPEED** = Minimum Speed. This Parameter sets the minimum voltage applied to the motor at the start of travel.
- 20 BACKING TIME = Activation time the backing function.
- 21 BACKING SPEED = Motor speed during the backing function.

5.5 TABLE OF ADJUSTMENTS

The following Table shows the different values that the SEM-1C Parameters may be adjusted to. A suitable acceleration performance assumes: FIELD CURR. NOM is set to level 5, and MAX SPEED (Fwd or Rev) is set to level 9.

PARAMETERS	PROGRAMMED LEVEL										
	UNIT	0	1	2	3	4	5	6	7	8	9
ACC. DELAY	sec.	0.30	0.50	0.70	0.90	1.10	1.25	1.40	1.55	1.75	2.00
DEC. DELAY	*	9	8	7	6	5	4	3	2	1	0
RELEASE BRAKING	*	0	1	2	3	4	5	6	7	8	9
INVERS BRAKING	*	0	1	2	3	4	5	6	7	8	9
SOFT BRAKING	** %	50	40	33	28	25	22	20	18	16	15
SOFT ACCELERATION	*** %	50	40	33	28	25	22	20	18	16	15
CUTBACK SPEED 1	%ACC	30	38	45	51	57	64	72	80	90	100
CUTBACK SPEED 2	%ACC	30	38	45	51	57	64	72	80	90	100
H&S CUTBACK	%ACC	30	38	45	51	57	64	72	80	90	100
MAX SPEED FORW.	%FCN	100	90	80	71	62	53	45	40	36	33
MAX SP FORW. FINE	**** %FCN	0	1	2	3	4	5	6	7	8	9
MAX. SPEED BACK.	%FCN	100	90	80	71	62	53	45	40	36	33
MAX SP BACK. FINE	**** %FCN	0	1	2	3	4	5	6	7	8	9
COMPENSATION	***** %I _A	0	5	10	16	22	27	33	38	44	78
MAXIMUM CURRENT	%IMax	82	84	86	88	90	92	94	96	98	100
ARMA CUR. NOM. (ACN)	%IMax	45	47	50	52	54	56	58	61	63	65
WEAK DROP OUT	%ACN	40	44	48	52	57	62	66	70	75	80
FIELD CURR. NOM. (FCN)	A	7.5	8.1	8.7	9.3	10	10.6	11.2	11.8	12.5	13.1
CREEP SPEED	%VBatt	4	5	6	7	8	9	10	11	12	13
BACKING TIME	sec.	1.6	1.9	2.1	2.4	2.7	3.0	3.2	3.5	3.8	4.1
BACKING SPEED	%max sp.	19.6	23.5	27.4	31.3	35.3	39.2	43.1	47.0	51.0	55.0

*= If the current inclines to raise, then also the braking time raises in order to obtain a smooth braking action. Therefore, the duration of the braking depends on the type of motor and the operating conditions (laden, unladen, on plane, on gradient).

**= The values in the table indicate how much the brakings (release, inversion, deceleration) are reduced while H&S function is active.

***= The values in the table indicate how much the acceleration is reduced while H&S function is active.

****= Is a percentage of the field current which is subtracted to the value defined by the parameters MAX SPEED FORW and MAX SPEED BACK.

*****= Indicates the percentage of the armature current (while the machine is at constant maximum speed) that is subtracted to the field current.

Flow Chart showing how to make Programme changes using Digital Console fitted with Eprom CK ULTRA.

- 1) Opening Zapi Display.
- 2) Press ENTER to go into the General Menu.
- 3) The Display will show :
- 4) Press ENTER to go into the Parameter Change facility.
- 5) The Display will show the first Parameter.
- 6) Press either ROLL UP or ROLL DOWN to display the next parameter.
- 7) The names of the Parameters appear on the Display.
- 8) When the desired Parameter appears, the Display will show a Level Number that will be between 0 and 9. press either PARAM (Top Right) or SET (Bottom Right) buttons to change the Level value.
- 9) The Display will show the New Level.
- 10) When you are satisfied with the results of the changes you have made, Press OUT.
- 11) The Display asks " ARE YOU SURE ?
- 12) Press ENTER to accept the changes, or Press OUT if you do not wish to accept the changes and wish to make further modifications to the parameters.
- 13) The Display will show :

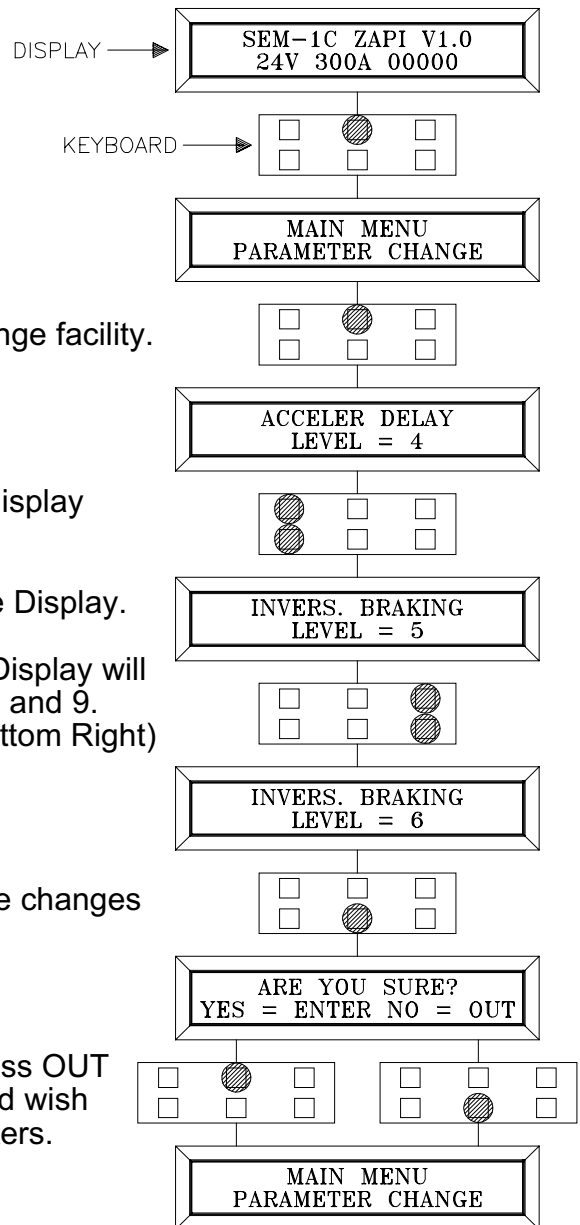

5.6 SEM-1C TRACTION STANDARD WIRING DIAGRAMS

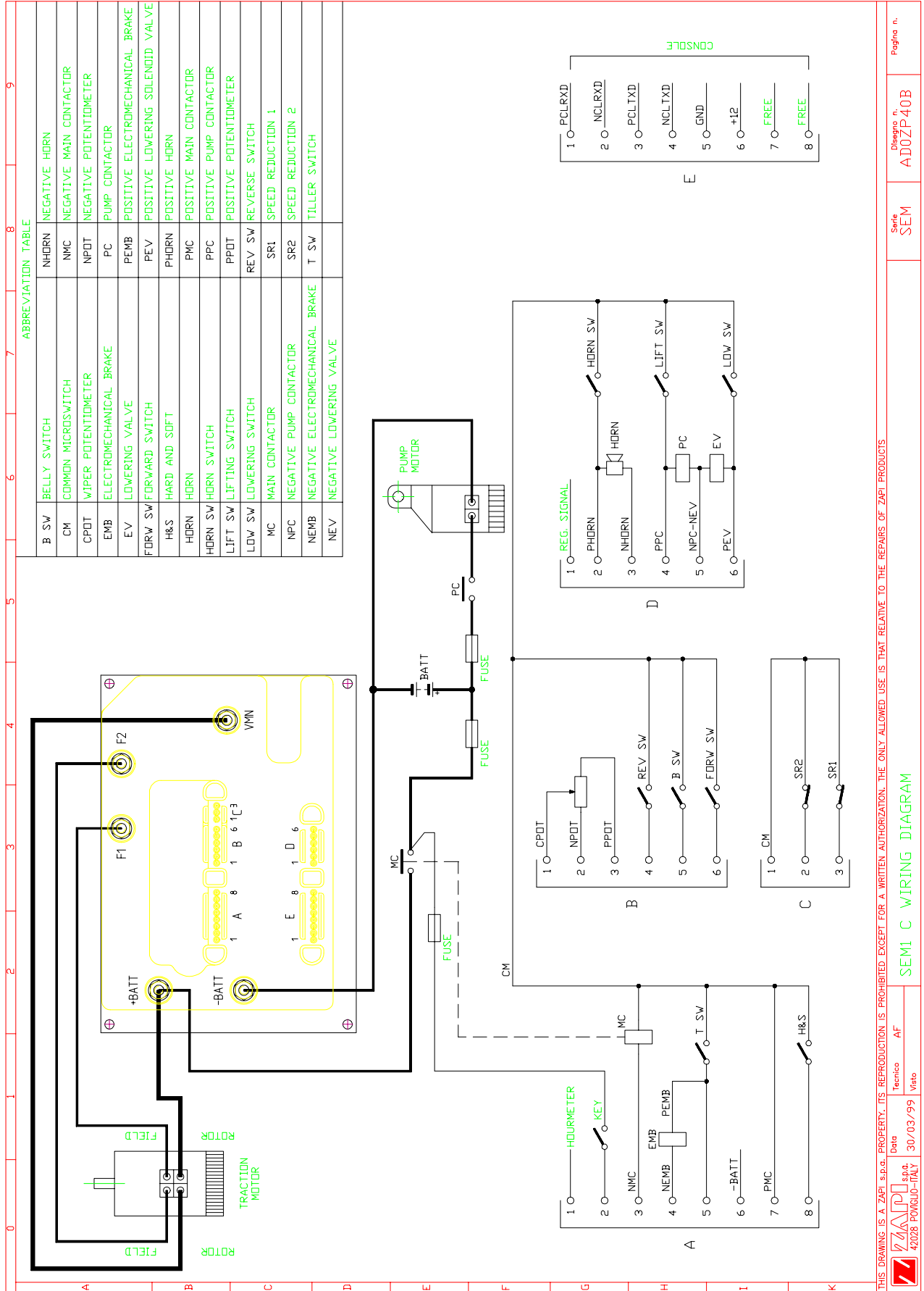

THIS DRAWING IS A ZAPI S.p.A. PROPERTY. ITS REPRODUCTION IS PROHIBITED EXCEPT FOR A WRITTEN AUTHORIZATION. THE ONLY ALLOWED USE IS THAT RELATIVE TO THE REPAIRS OF ZAPI PRODUCTS.

Data
 4028 P01010-ITALY
 s.p.a.
 AF
 30/03/99
 Technico
 vito

SEMI C WIRING DIAGRAM

Serie
SEM
 Disegno n.
A00ZP40B

Pagina n.

5.7 SEQUENCE FOR SEM-1C TRACTION SETTINGS.

When the Key Switch is Closed, if no Alarms or Errors are present, the Console Display will be showing the Standard Zapi Opening Display.

If the chopper is not Configured to your requirements, follow the Sequence detailed on Page 20. Remember to re-cycle the Key Switch if you make any changes to the chopper's Configuration. Otherwise follow the sequence detailed below :

- 1) Select the options required (Chapter 5.3).
- 2) Select and set the Battery Voltage.
- 3) Confirm correct installation of all wires. Use the Console's TESTER function to assist.
- 4) Perform the accelerator signal acquisition procedure using the Console "PROGRAM VACC".
- 5) Set the TRACTION IMAX Current, taking into account any Boost requirements. Use Table on Chapter 5.5.
- 6) Set the Acceleration Delay requirements for the machine. Test the parameters in both directions.
- 7) Set the CREEP level starting from level 0. The machine should just move when the accelerator microswitch is closed. Increase the Level accordingly.
- 8) Set the Speed Reductions as required. Make adjustments to CUTBACK SP.1, 2. Check the performance with the accelerator pedal totally depressed. If the machine is a forklift, check the performance with and without load.
- 9) RELEASE BRAKING. Operate the machine at full speed. Release the accelerator pedal. Adjust the level to your requirements. If the machine is a forklift, check the performance with and without load.
- 10) INVERSION BRAKING. Operate the machine at 25% full speed. Whilst traveling invert the Direction Switch. Set a soft Level of Inversion Braking. When satisfactory, operate the machine at Full Speed and repeat. If the machine is a Forklift, repeat the tests and make adjustments with and without load. The unladen full speed condition should be the most representative condition.
- 11) Set MAX SPEED FORW.
- 12) Set MAX SPEED BACK (Reverse).
- 13) Set ARMA CURR. NOM., NOM. FIELD CURR. e WEAK DROPOUT

Check the parameters meaning on Chapter 5.4.

6 SEM-1C DIAGNOSTICS

The following list shows likely problems associated with the flashing RED LED.

N° FLASHES	MESSAGE	NOTES
1	LOGIC FAILURE #1	Problem with Logic or Line Contactor.
1	WATCH-DOG	Logic board and/or software failure.
1	EEPROM KO	Problem with EEPROM or Logic.
2	INCORRECT STARTS	Starting sequence for travel not correct.
2	FORW + BACK	Double running requests.
3	CAPACITOR CHARGE	Problem in Power Block.
3	VMN NOT OK	Problem with Chopper.
3	VFIELD NOT OK	Problem with Field Voltage
4	VACC NOT OK	Potentiometer Wiper.
4	PEDAL WIRE KO	Pedal wire not OK.
5	NO FIELD CUR.	Field wiring not OK or field current sensor not OK.
5	HIGH FIELD CUR.	Field wiring not OK or field current sensor not OK.
5	STBY I HIGH	High current at the stand-by sensor of armature current not OK.
5	I= 0 EVER	No current: sensor of armature current not OK.
6	CONTACTOR DRIVER	Contacteur Driver not OK.
6	COIL SHORTED	Coil contactor shorted.
6	CONTACTOR CLOSED	Line Contactor contact not OK.
7	TH. PROTECTION	Temperature too much high (>70°C) or low (<10°C).
32	BATTERY LOW	Battery too low.

6.1 ANALYSIS OF ALARMS DISPLAYED ON THE CONSOLE

1 LOGIC FAILURE #1

This test is carried out at the start-up.

Possible cause: failure of the logic board

2 WATCH DOG

The test is executed at the key turn-on, at the stand-by and on running. Possible causes:

a) Watch-dog hardware circuit not OK;

b) Software not OK.

3 EEPROM OK

Fault in the area of memory where the adjustment parameters are stored. This Alarm inhibits machine operation. If the fault continues when the Key Switch is re-cycled, replace the logic. If the fault disappears, the previously stored Parameters will have been replaced by the default parameters.

4 INCORRECT START

Alarm generated by an incorrect Starting Sequence. Possible causes:

a) The ENABLE microswitch has welded or failed.

b) Error in the starting sequence from the operator.

c) Error in the wiring.

5 FORW + BACK

This check is made continually. The alarm is generated when forward and reverse direction are requested simultaneously. Possible causes:

a) Error in Wiring.

b) Welding or Failure of a direction switch.

c) Error in the starting sequence from the operator.

6 CAPACITOR CHARGE

This check is made during the initial diagnosis. This Alarm is generated if the Capacitors are not charged within 500ms after the Key Switch is closed. Probable cause is failure inside the power block.

7 VMN NOT OK

This test is performed at rest, with the general Contactor Closed, and also during operation. At rest if VMN is lower than battery voltage this Alarm is generated.

During operation this Alarm is generated if VMN doesn't follow the duty-cycle of the chopper. Possible causes:

a) Incorrect Motor connection.

b) Short circuit motor windings to chassis.

c) Defect in the power unit.

8 VFIELD NOT OK

This test is made at standby with the Line Contactor open. In this condition the voltages on both the connections of field must be to around $\frac{1}{2}$ VBatt. This alarm is generated if the field voltage is different from this value. Possible causes:

- d) Frame fault on the motor to chassis;
- e) Incorrect connection of the field winding to the controller;
- f) Failure of the controller in the section relative to the field.

9 VACC NOT OK

This Alarm is generated if the accelerator output voltage differs more than 2V from the acquired minimum during the PROGRAM VACC. Possible causes:

- a) the track of the potentiometer has become open.
- b) the potentiometer is not wired correctly.
- c) the potentiometer itself is defective.
- d) the values set in PROGRAM VACC routine have not remained or made correctly.

10 PEDAL WIRE KO

This Alarm is generated if potentiometer or wiring fault is detected. (NPOT or PPOT are open circuit).

11 STBY I HIGH

This test is made during the initial diagnosis and at standby. The test verifies that the current is zero. This Alarm disables the machine. Possible causes:

- a) defective current sensor.
- b) logic failure. First replace the logic. If fault remains replace the power unit.

12 I = 0 EVER

This check is made during travel. If the current is not higher than a preset minimum value, this Alarm is generated and the machine disabled. Possible causes: see STBY I HIGH. Check the motor armature (brush connections).

13 HIGH FIELD CUR, NO FILD CUR

Problem detected with the field winding current. Possible causes:

- a) Failure of the field current sensor.
- b) Field cables not connected or incorrectly connected.
- c) Failure of the Field Power Unit.

14 CONTACTOR DRIVER, COIL SHORTED, DRIVER SHORTED

These Alarms are generated if there is a problem with the General or Line Contactor. Possible causes:

- a) The coil of the contactor is either short-circuit, open circuit, or not connected.
- b) The Contactor Coil Driver is short-circuit.
- c) Defect in the wiring to the contactor, or logic failure.

15 CONTACTOR CLOSED

This check is made during the initial diagnosis. With the coil of the line contactor de-energized, the capacitors should not be charged, unless there is divert resistor across the power poles. Possible causes:

- a) The line contactor power poles are welded.
- b) This alarm could be generated even if the line contactor has opened, but there is a problem with either the field circuit, or a problem detected by the safety micro-processor.

16 TH. PROTECTION

If the temperature of the chopper rises higher than 70°C, this alarm is generated. The chopper current is reduced in proportion to the increase in temperature. At 80°C the chopper totally stops. If the temperature of the chopper is <- 10°C, this Alarm is also generated and the current is reduced by 80 %. If this alarm is displayed when the chopper is temperature is the same as ambient or better than zero degrees:

- a) Check the connection of the temperature sensor.
- b) The temperature sensor may be defective.
- c) The logic may be defective.

17 BATTERY LOW

This Alarm is generated when the battery becomes 50% discharged from the nominal value.

6.2 TESTER DESCRIPTION OF THE FUNCTIONS

The most important input or output signals can be measured in real time using the TESTER function of the console. The Console acts as a multimeter able to read voltage, current and temperature. The following definition listing shows the relative measurements :

- 1) **BATTERY VOLTAGE:** level of battery voltage measured at the input to the key switch.
- 2) **MOTOR VOLTAGE:** the voltage appearing across the drive motor. It is measured between B+ and VMN.
- 3) **MOTOR CURRENT:** the current flowing in the drive motor armature.
- 4) **FIELD CURRENT:** the current flowing in the drive motor field winding.
- 5) **VMN:** the voltage effectively dropped across the MOS. It is measured between B- and VMN.
- 6) **TEMPERATURE:** the temperature measured on the aluminum heat sink holding the MOSFET devices.
- 7) **ACCELERATOR:** the voltage of the accelerator potentiometer wiper (CPOT).
The voltage level is shown on the Left Hand Side of the Console Display and the value in percentage is shown on the Right Hand Side.
- 8) **FORWARD SWITCH:** the level of the Forward direction digital entry MA (pin B6).
ON /+ VB = active entry of closed switch.
OFF / GND = non active entry of open switch.
- 9) **BACKWARD SWITCH:** the level of the Reverse direction digital entry MI (pin B4).
ON /+ VB = active entry of closed switch.
OFF / GND = non active entry of open switch.
- 10) **HANDLE/SEAT SWITCH:** the level of the Handle/Seat Microswitch digital entry (pin A5).
ON / + VB = active entry of closed seat switch.
OFF / GND = non active entry of open seat switch.
- 11) **QUICK INVERSION:** the level of the digital entry from Belly Button microswitch (pin B5).
ON /+ VB = active entry, B SW closed.
OFF / GND = non active entry, B SW open.
- 12) **CUTBACK SWITCH 1:** the level of the Speed Reduction 1 Microswitch SR1.
ON / GND = active entry of speed reduction microswitch.
OFF / + VB = non active entry of microswitch.
- 13) **CUTBACK SWITCH 2:** the level of the Speed Reduction 2 Microswitch SR2.
ON / GND= active entry of speed reduction microswitch.
OFF / +VB = non active entry of microswitch.

Flow Chart showing how to use the TESTER function of the Digital Console.

1) Opening Zapi Display.

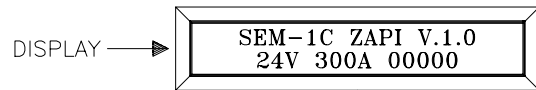

2) Press ENTER to go into the General menu.

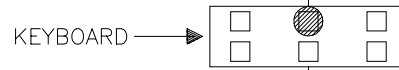

3) The Display will show :

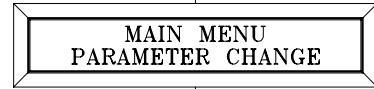

4) Press either ROLL UP or ROLL DOWN button until TESTER MENU appear on the display.

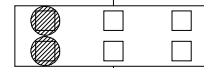

5) The Display shows :

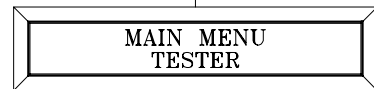

6) Press ENTER to go into the TESTER function.

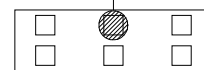

7) The first variable to be tested is shown on the Display.

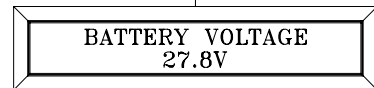

8) Press either ROLL UP or ROLL DOWN buttons until your desired variable for measurement appears on the Display.



9) Next variable is shown.

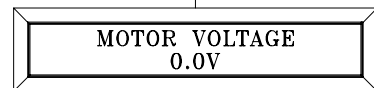

10) When you have finished, Press OUT.

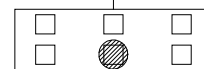

11) The Display shows :

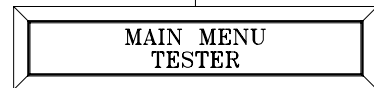

12) Press either ROLL UP or ROLL DOWN button to show other MENU or press OUT to finish.

Remember it is not possible to make any changes using TESTER. All you can do is measure as if you were using a pre-connected multimeter.

6.3 DESCRIPTION OF THE CONSOLE SAVE FUNCTION

The **SAVE PARAM** function allows the operator to transmit the Parameter values and Configuration data of the chopper into the Console memory. It is possible to load 64 different programmes.

The information saved in the Console memory can then be reloaded into another chopper using the **RESTORE** function.

The data that is available via the SAVE function is as follows:

- All Parameter Values (PARAMETER CHANGE).
- Options (SET. OPTIONS).
- The Level of the Battery (ADJUST BATTERY).

Flow Chart showing how to use the SAVE function of the Digital Console.

1) Opening Zapi Display.

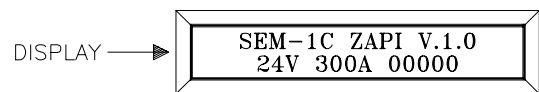

2) Press ENTER to go into the General menu.

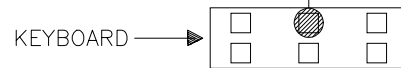

3) The Display will show :

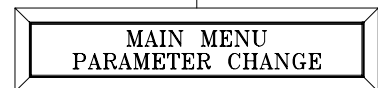

4) Press either ROLL UP or ROLL DOWN button until SAVE PARAM. is shown.

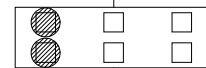

5) The Display will show :

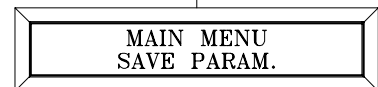

6) Press ENTER to go into the SAVE function.

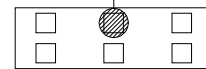

7) If this facility has been used before the type of chopper data stored appears on the top line with a 2 digit reference.

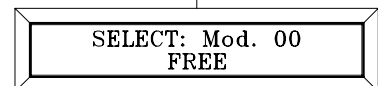

8) Keep pressing either ROLL UP or ROLL DOWN keys until the second line indicates a FREE storage facility.

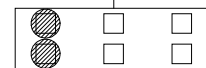

9) Press ENTER to commence SAVE routine.

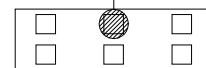

10) You can see the items that are being stored whilst the SAVE routine is happening.

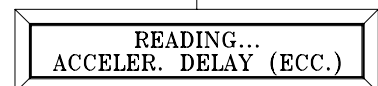

11) When finished, the Console shows :

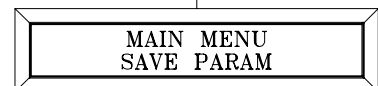

12) Press OUT to return to the Opening Zapi Display.

6.4 DESCRIPTION OF CONSOLE RESTORE FUNCTION.

The RESTORE PARAM function allows transfer of the Console's stored data into the memory of the chopper. This is achieved in a fast and easy way using the method previously used with the SAVE PARAM. function.

The data that are available via the RESTORE PARAM. function are as follows :

- All Parameter Values (PARAMETER CHANGE).
- Options (SET OPTIONS)
- The level of the Battery (ADJUST BATTERY)

ATTENTION: When the RESTORE operation is made, all data in the chopper memory will be written over and replaced with data being restored.

Flow Chart showing how to use the RESTORE function of the Digital Console.

1) Opening Zapi Display.

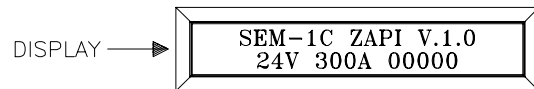

2) Press ENTER to go into the General menu.

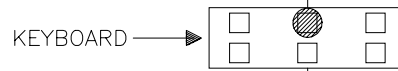

3) The Display will show :

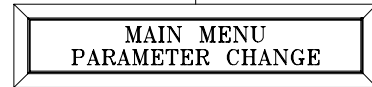

4) Press either ROLL UP or ROLL DOWN button until RESTORE PARAM. appears on the display.

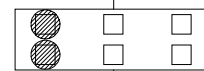

5) The Display will show :

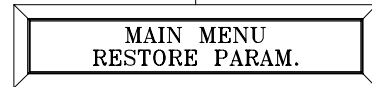

6) Press ENTER to go into the RESTORE PARAM. function.

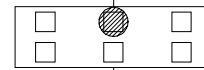

7) The Display shows the type of Model stored, with a Code Number.

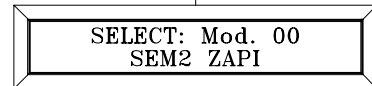

8) Keep pressing either ROLL UP and ROLL DOWN buttons until the desired model appears on the Display.

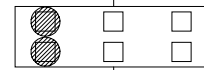

9) The model is shown

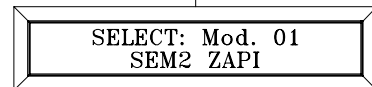

10) Press ENTER to commence the Restore operation.

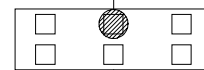

11) The Display will ask "ARE YOU SURE". Press ENTER for YES, or OUT for No.

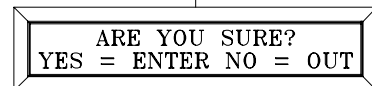

12) Press ENTER to confirm (OUT to not confirm)



13) You can see the items that are being stored in the chopper memory whilst the RESTORE routine is happening.



14) When finished the Console displays :



15) Press OUT to return to the Opening Zapi Display .

6.5 DESCRIPTION OF ALARMS MENU.

The microprocessor in the chopper remembers the last five Alarms that have occurred. Items remembered relative to each Alarm are : the code of the alarm, the number of times the particular Alarm occurred, the Hour Meter count, and the chopper temperature.

This function permits a deeper diagnosis of problems as the recent history can now be accessed.

Flow Chart showing how to use the ALARMS function via the Digital Console.

1) Opening Zapi Display.

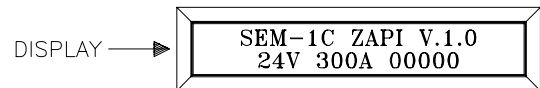

2) Press ENTER to go into the General menu.

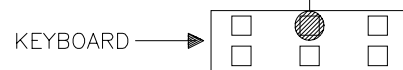

3) The Display will show :

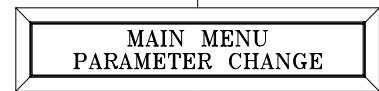

4) Press ROLL UP or ROLL DOWN button until PARAMETER CHANGE appears on the display.

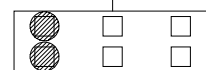

5) The Display will show:

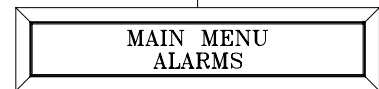

6) Press ENTER to go into the ALARMS function.

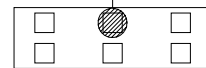

7) The Display will show the most recent Alarm.

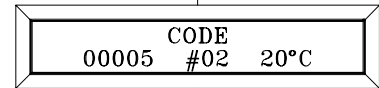

8) Each press of the ROLL UP button brings up following Alarms. Pressing ROLL DOWN returns to the most recent.

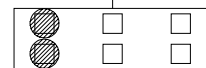

9) If an Alarm has not occurred, the Display will show: ALARM NULL.

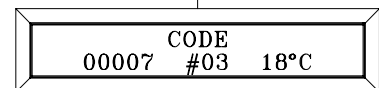

10) When you have finished looking at the Alarms, press OUT to exit the ALARMS menu.

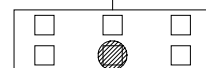

11) The Display will ask CLEAR LOGBOOK ?

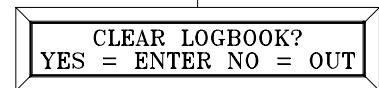

12) Press ENTER for yes, or OUT for NO.

13) Press OUT to return to the Opening Zapi Display.

6.6 DESCRIPTION OF CONSOLE PROGRAM VACC FUNCTION.

This function looks for and remembers the minimum and maximum potentiometer wiper voltage over the full mechanical range of the pedal. It enables compensation for non symmetry of the mechanical system between directions. The operation is performed by operating the pedal after entering the PROGRAM VACC function.

Flow Chart showing how to use the PROGRAM VACC function of the Digital Console.

1) Opening Zapi Display.

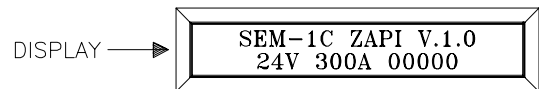

2) Press ENTER to go into the General Menu.

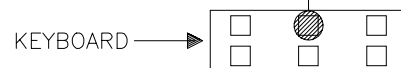

3) The Display will show :

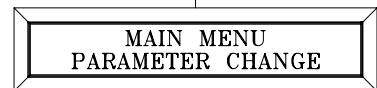

4) Press ROLL UP or ROLL DOWN button until PROGRAM VACC appears on the display.

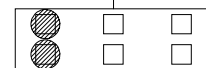

5) The Display will show :

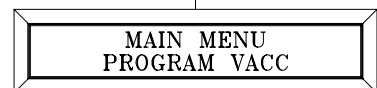

6) Press ENTER to go into the PROGRAM VACC routine.

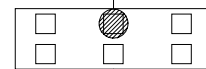

7) The Display will show the minimum and maximum values of potentiometer wiper output. Both directions can be shown.

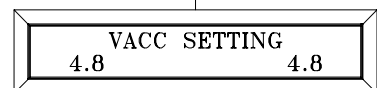

8) Press ENTER to clear these values.

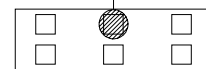

9) Display will show 0.0.

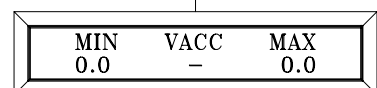

10) Select Forward Direction, close any interlock switches that may be in the system. Slowly depress the accelerator pedal (or tiller butterfly) to its maximum value. The new minimum and maximum voltages will be displayed on the Console plus an arrow indicating the direction.

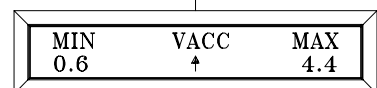
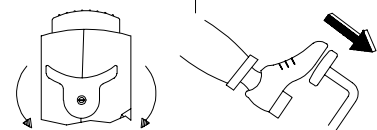

11) Select the Reverse Direction and repeat Item 10.

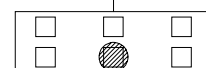

12) When finished, press OUT.

13) The Display will ask : ARE YOU SURE ?.

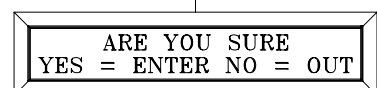

14) Press ENTER for yes, or OUT for NO.

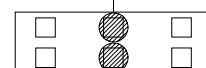

15) Press OUT again to return to the Opening Zapi Menu.

7 RECOMMENDED SPARE PARTS FOR SEM-1C

Part Number	Description
C16529	Protected 125A Fuse.
C16503	Protected 200A Fuse
C16520	6.3A 5x20mm Control Circuit Fuse
P99060	Red LED
C12372	8 Way Molex Connector
C12416	6 Way Molex Connector
C12371	3 Way Molex Connector
C12769	Insert for Molex Connectors
C29548	SW 80B-548 24V
C29504	SW80B-551 36V
C29506	SW80B-552 48V

8 PERIODIC MAINTENANCE TO BE REPEATED AT TIMES INDICATED

Check the wear and condition of the Contactors' moving and fixed contacts. Electrical Contacts should be checked every **3 months**.

Check the Foot pedal or Tiller microswitch. Using a suitable test meter, confirm that there is no electrical resistance between the contacts by measuring the volt drop between the terminals. Switches should operate with a firm click sound. Microswitches should be checked every **3 months**.

Check the Battery cables, cables to the chopper, and cables to the motor. Ensure the insulation is sound and the connections are tight. Cables should be checked every **3 months**.

Check the mechanical operation of the pedal or tiller . Are the return springs ok. Do the potentiometers wind up to their full or programmed level. Check every **3 months**.

Check the mechanical operation of the Contactor(s). Moving contacts should be free to move without restriction. Check every **3 months**.

Checks should be carried out by qualified personnel and any replacement parts used should be original. Beware of NON ORIGINAL PARTS.

The installation of this electronic controller should be made according to the diagrams included in this Manual. Any variations or special requirements should be made after consulting a Zapi Agent. The supplier is not responsible for any problem that arises from wiring methods that differ from information included in this Manual.

During periodic checks, if a technician finds any situation that could cause damage or compromise safety, the matter should be brought to the attention of a Zapi Agent immediately. The Agent will then take the decision regarding operational safety of the machine.

Remember that Battery Powered Machines feel no pain.

NEVER USE A VEHICLE WITH A FAULTY ELECTRONIC CONTROLLER.